

VICTRONIX	Add:	Room 1405A, Building 1B, Hua qiang Idea Park, GuangMing District, Shenzhen, China		
	Tel:	+86-755-33265935	Fax :	+86-755-33265935

SPECIFICATION

VXT101MBAH-02

- Preliminary Specification
- Final Specification

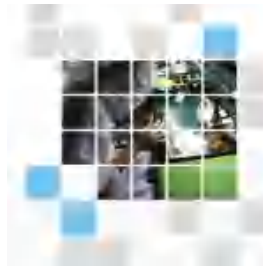

CUSTOMER:

Made By:
Checked By:
Approved By:
Quality:
Date:
Note:

-

Approved By:
Date:
Note:

2. Revision Record

Date	Rev.No.	Page	Revision Items	Prepared
2015-01-07	V00		The first release	Solon
2015-11-17	V01		Delete the quality level and update the format	Solon
2018-07-27	V02		Update the drawing	Solon

3. General Specifications

VXT101MBAH-02 is a TFT-LCD module. It is composed of a TFT-LCD panel, driver IC, FPC, a back light unit. The 10.1" display area contains 1024 x 600 pixels and can display up to 16.7M colors. This product accords with RoHS environmental criterion.

Item	Contents	Unit	Note
LCD Type	TFT	-	
Display color	16.7M		
Viewing Direction	12	O'Clock	
Gray scale inversion direction	6	O'Clock	
Operating temperature	-20~+70	°C	
Storage temperature	-30~+80	°C	
Module size	Refer to outline drawing	mm	
Active Area(W×H)	222.72X125.28	mm	
Number of Dots	1024×600	dots	
Controller	HX8282-A14 & HX8696	-	
Power Supply Voltage	3.3	V	
Outline Dimensions	Refer to outline drawing	-	
Backlight	3X13-LEDs (white)	pcs	
Weight	---	g	
Interface	LVDS	-	

4.Outline Drawing

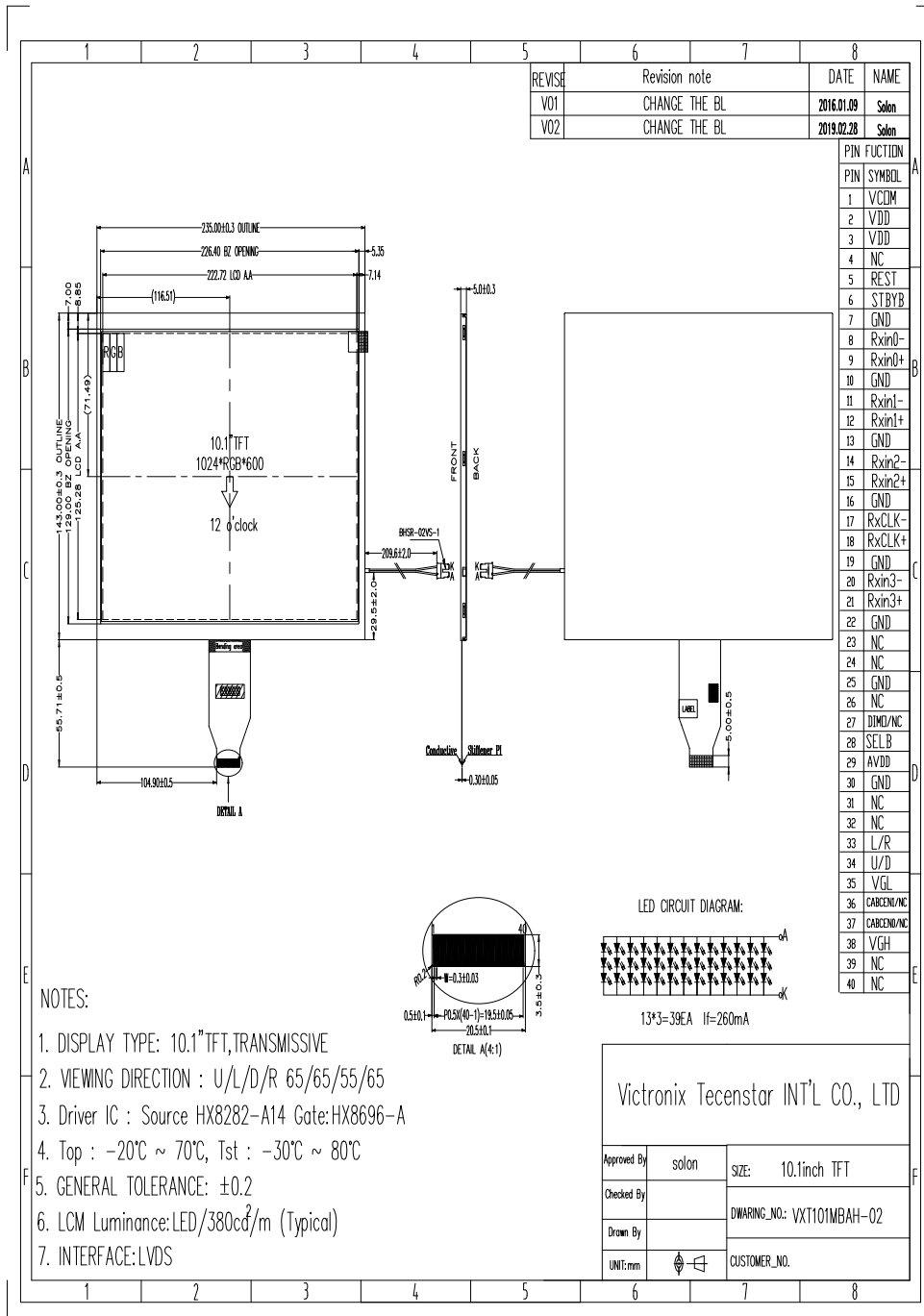

5. Absolute Maximum Ratings(Ta=25°C)

5.1 Electrical Absolute Maximum Ratings.(Vss=0V ,Ta=25°C)

Item	Symbol	Min.	Max.	Unit	Note
Power Supply Voltage	VDD	-0.50	3.96	V	1, 2
	AVDD	-0.5	14.85	V	
	VGH	-0.3	VGL+42	V	
	VGL	-25	0.3	V	
	V _{GH} -V _{GL}	-	40.0	V	

Notes:

1. If the module is above these absolute maximum ratings. It may become permanently damaged. Using the module within the following electrical characteristic conditions are also exceeded, the module will malfunction and cause poor reliability.
2. V_{DD} >V_{SS} must be maintained.
3. Please be sure users are grounded when handing LCD Module.

5.2 Environmental Absolute Maximum Ratings.

Item	Storage		Operating		Note
	MIN.	MAX.	MIN.	MAX.	
Ambient Temperature	-30°C	80°C	-20°C	70°C	1,2
Humidity	-	-	-	-	3

1. The response time will become lower when operated at low temperature.
2. Background color changes slightly depending on ambient temperature.
The phenomenon is reversible.
3. Ta<=40°C:85%RH MAX.

Ta>=40°C:Absolute humidity must be lower than the humidity of 85%RH at 40°C.

6. Electrical Specifications and Instruction Code

6.1 Electrical characteristics(V_{SS}=0V ,T_a=25°C)

Parameter	Symbol	Condition	Min	Typ	Max	Unit	Note	
Power supply	VDD	T _a =25°C	3.0	3.3	3.6	V		
Power supply	VGH	T _a =25°C	17	21	23	V		
Power supply	VGL	T _a =25°C	-9.0	-8	-5	V		
Power supply	AVDD	T _a =25°C	10.1	10.5	10.9	V		
Power supply	VCOM	T _a =25°C	3.4	3.7	4.0	V		
Input voltage	'H'	V _{IH}	V _{DD} =3.3V	0.7V _{DD}	-	V _{DD}	V	
	'L'	V _{IL}	V _{DD} =3.3V	0	-	0.3V _{DD}	V	

Note: 1: Tested in 1×1 chessboard pattern.

6.2 LED backlight specification(V_{SS}=0V ,T_a=25°C)

Item	Symbol	Condition	Min	Typ	Max	Unit	Note
Supply voltage	V _f	I _f =260mA	8.1	9.0	9.9	V	
Uniformity	Δ Bp	I _f =260mA	75	80	-	%	
Life Time	time	I _f =260mA	20K	-		hours	1

Note 1: Brightness to be decreased to 50% of the initial value at ambient temperature T_A=25°C

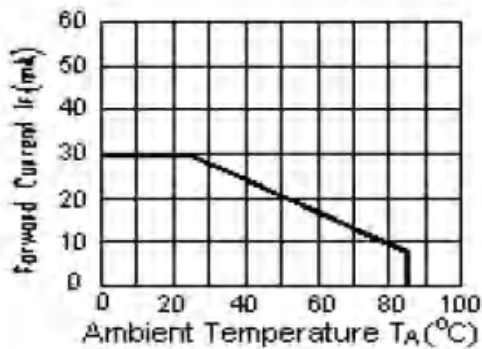

I_{LED} VS TEMP

6.3 Interface signals

Pin No.	Symbol	I/O	Function
1	VCOM	P	Common voltage
2-3	VDD	P	Power for digital circuit
4	NC	-	No connection
5	REST	I	Global reset pin
6	STBYB	I	Stand mode: STBYB=1,normal operation STBYB=0,timing control,source driver will turn off,all output are high-Z
7	GND	P	Ground
8	Rxin0-	I	-LVDS differential data input
9	Rxin0+	I	+LVDS differential data input
10	GND	P	Ground
11	Rxin1-	I	-LVDS differential data input
12	Rxin1+	I	+LVDS differential data input
13	GND	P	Ground
14	Rxin2-	I	-LVDS differential data input
15	Rxin2+	I	+LVDS differential data input
16	GND	P	Ground
17	RxCLK-	I	-LVDS differential clock input
18	RxCLK+	I	+LVDS differential clock input
19	GND	P	Ground
20	Rxin3-	I	-LVDS differential data input
21	Rxin3+	I	+LVDS differential data input
22	GND	P	Ground
23-24	NC	-	No connection
25	GND	P	Ground
26	NC	-	No connection
27	DIMO/NC	I	Backlight CABC controller signal output
28	SELB	I	6bit/8bit select H:6bit, L:8bit
29	AVDD	P	Power for analog circuit
30	GND	P	Ground
31-32	NC	-	No connection
33	L/R	I	Horizontal inversion
34	U/D	I	Vertical inversion
35	VGL	P	Negative power for TFT
36	CABCEN1/NC	I	CABC H/W enable

37	CABCEN0/NC	I	CABC H/W enable
38	VGH	P	Positive power for TFT
39-40	NC	-	No connection

7. Optical Characteristics

Item	Symbol	Condition	Min.	Typ.	Max.	Unit	Note	
Brightness	Bp	$\theta=0^\circ$	300	380	-	Cd/m ²	1	
Uniformity	Δ Bp	$\Phi=0^\circ$	75	80	-	%	1,2	
Viewing Angle	3:00	Cr \geq 10	-	65	-	Deg	3	
	6:00		-	55	-			
	9:00		-	65	-			
	12:00		-	65	-			
Contrast Ratio	Cr	Ta=25°C $\Phi=0^\circ$	500	600	-	-	4	
Response Time	T _r +T _f		-	25	40	ms	5	
Color of CIE Coordinate	W	x	$\theta=0^\circ$ $\Phi=0^\circ$	TYP- 0.05	TYP+0 .05	-	1,6	
		y				-		
	R	x				0.298		-
		y				0.334		-
	G	x				0.605		-
		y				0.327		-
	B	x				0.297		-
		y				0.563		-
S	x	0.144	-					
	y	0.169	-					
NTSC Ratio	S	-	50	-	%			

Note: The parameter is slightly changed by temperature, driving voltage and materiel

Note 1: The data are measured after LEDs are turned on for 5 minutes. LCM displays full white. The brightness is the average value of 9 measured spots. Measurement equipment BM-7 (Φ5mm)

Measuring condition:

- Measuring surroundings: Dark room.
- Measuring temperature: Ta=25°C.
- Adjust operating voltage to get optimum contrast at the center of the display.

Measured value at the center point of LCD panel after more than 5 minutes while backlight turning on.

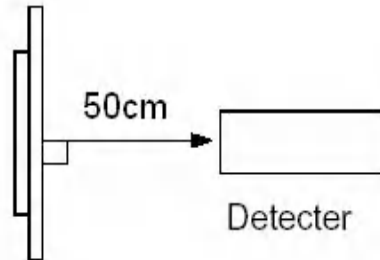

Note 2: The luminance uniformity is calculated by using following formula.

$$\Delta Bp = Bp (\text{Min.}) / Bp (\text{Max.}) \times 100 (\%)$$

$Bp (\text{Max.})$ = Maximum brightness in 9 measured spots

$Bp (\text{Min.})$ = Minimum brightness in 9 measured spots.

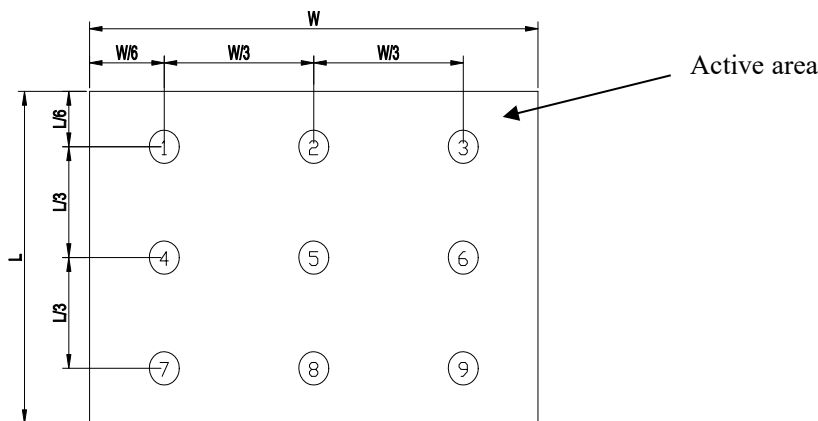

Note 3: The definition of viewing angle:

Refer to the graph below marked by θ and ϕ

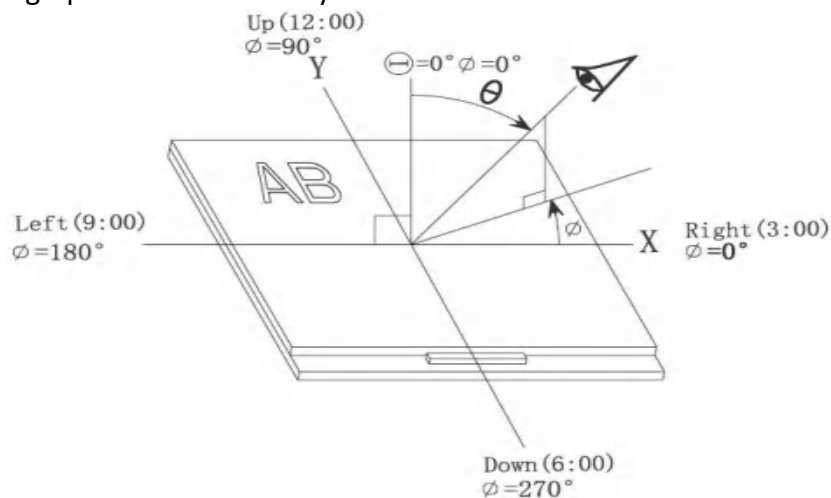

Note 4: Definition of contrast ratio.(Test LCD using DMS501)

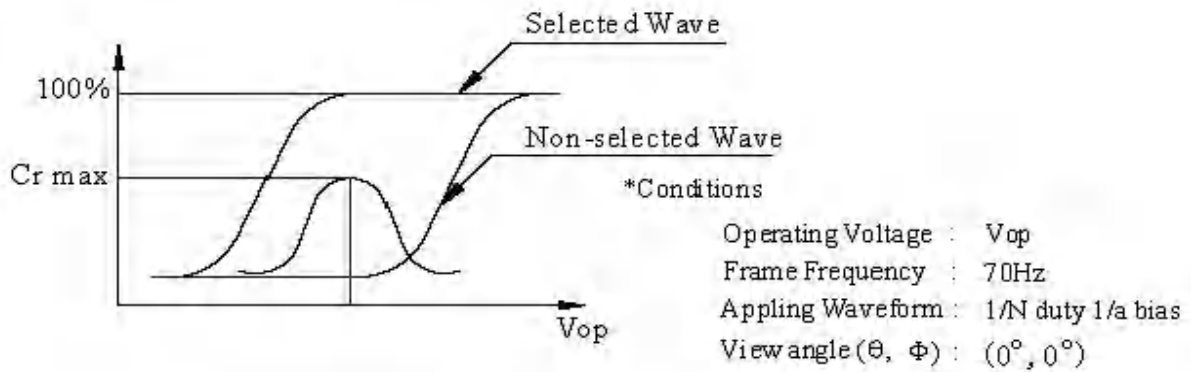

$$\text{Contrast ratio}(Cr) = \frac{\text{Brightness of selected dots}}{\text{Brightness of non-selected dots}}$$

Note 5: Definition of Response time. (Test LCD using DMS501):

The output signals of photo detector are measured when the input signals are changed from “black” to “white”(falling time) and from “white” to “black”(rising time), respectively. The response time is defined as the time interval between the 10% and 90% of amplitudes. Refer to figure as below.

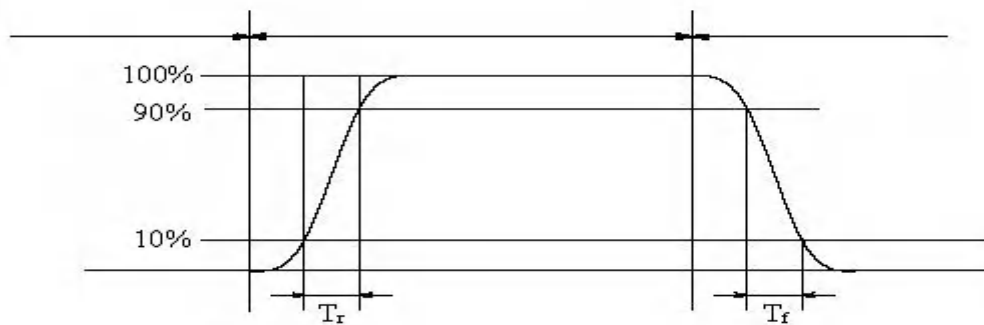

The definition of response time

Note 6: Definition of Color of CIE Coordinate and NTSC Ratio.

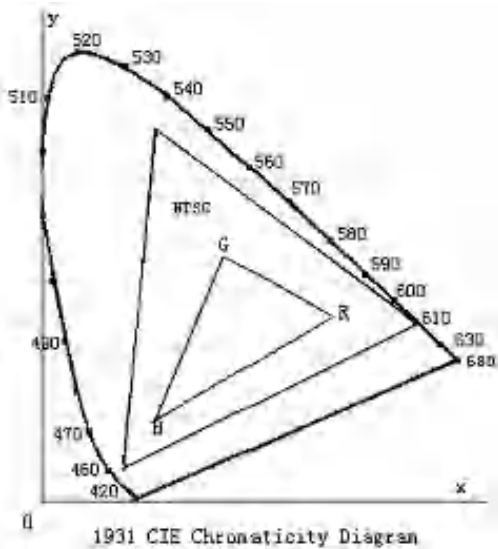

Color gamut:

$$S = \frac{\text{area of RGB triangle}}{\text{area of NTSC triangle}} \times 100\%$$

Note 7: Definition of cross talk.

Cross talk ratio(%)=|pattern A Brightness-pattern B Brightness|/pattern A Brightness*100

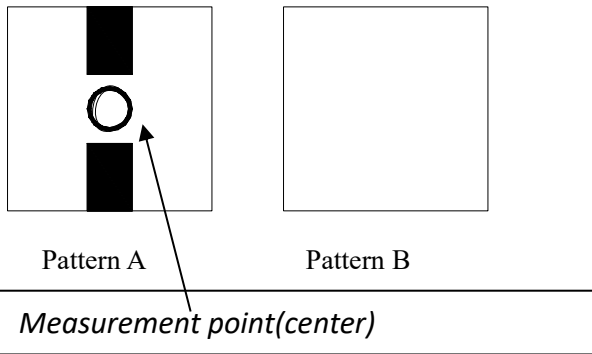

Electric volume value=3F+/-3Hex

8. Reliability Test Items and Criteria

No	Test Item	Test condition	Criterion
1	High Temperature Storage	80°C±2°C 96H Restore 2H at 25°C Power off	1. After testing, cosmetic and electrical defects should not happen. 2. Total current consumption should not be more than twice of initial value.
2	Low Temperature Storage	-30°C±2°C 96H Restore 2H at 25°C Power off	
3	High Temperature Operation	70°C±2°C 96H Restore 2H at 25°C Power on	
4	Low Temperature Operation	-20°C±2°C 96H Restore 4H at 25°C Power on	
5	High Temperature/Humidity Operation	60°C±2°C 90%RH 96H Power on	
6	Temperature Cycle	-30°C → 80°C 30min 5min 30min after 5 cycle, Restore 2H at 25°C Power off	

Note: Operation: Supply 3.3V for logic system.

The inspection terms after reliability test, as below

ITEM	Inspection
Contrast	CR>50%
IDD	IDD<200%
Brightness	Brightness>60%
Color Tone	Color Tone+/-0,05